

L:

CBL-HFPD203-1m	1000mm±20mm
CBL-HFPD203-2m	2000mm±20mm
CBL-HFPD203-3m	3000mm±30mm
CBL-HFPD203-4m	4000mm±30mm
CBL-HFPD203-5m	5000mm±50mm
CBL-HFPD203-6m	6000mm±50mm
CBL-HFPD203-7m	7000mm±50mm
CBL-HFPD203-8m	8000mm±50mm
CBL-HFPD203-9m	9000mm±50mm
CBL-HFPD203-10m	10000mm±50mm

USB A(M)		PIN OUT	USB B(M)	
1	—	RED	1	—
2	—	WHITE	2	—
3	—	GREEN	3	—
4	—	BLACK	4	—
SHELL	—	BRAID	SHELL	—

No	MATERIALS LIST:
1.	CABLE:UL2725 (26AWG*1PR+D+AM)x2C+24AWG*2C+AM+B OD:5.4mm PVC JACKET COLOR:BLACK
2.	CONNECTOR:USB 2.0 A/M, 4P, WHITE INSULATOR SOLDER TYPE, NICKEL PLATED SHELL
3.	CONNECTOR:USB 2.0 B/M, 4P, WHITE INSULATOR SOLDER TYPE, NICKEL PLATED SHELL
4.	PVC MOLDED HOUSING, BLACK COLOR

Jargy part no.	Client part no.	Approved	SCALE	UNIT
CBL-HFPD203-Xm			1 : 1	mm
Drawing Name		Drawn	Date	REV.
USB 2.0 A to B Cable M/M		<i>Kevin Asu</i>	2015/09/04	1.0

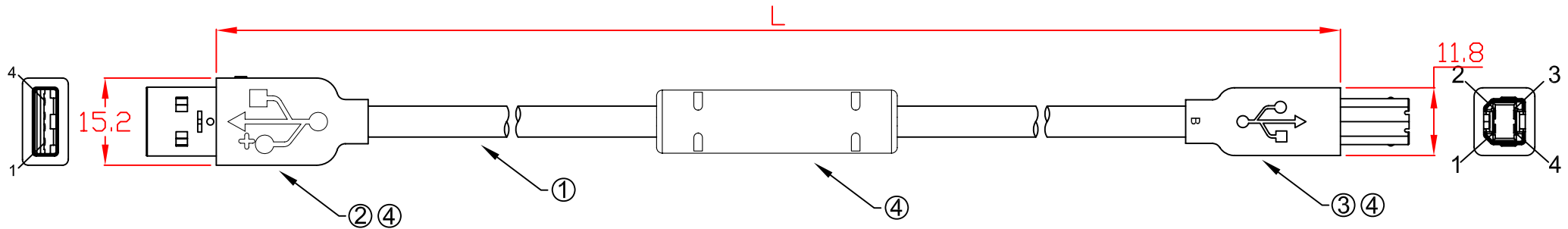
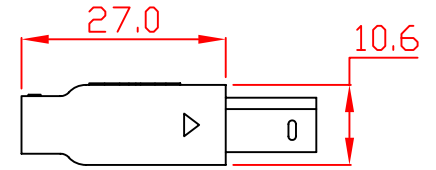
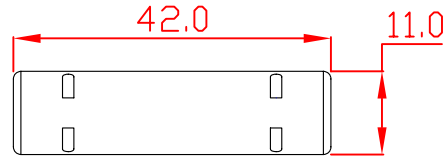
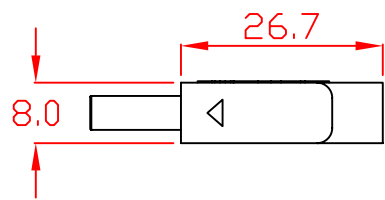

L:
 CBL-HFD203-15m 15000mm±50mm
 CBL-HFD203-20m 20000mm±50mm

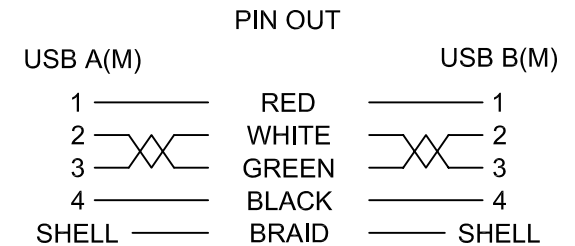

No	MATERIALS LIST:
1.	CABLE:UL2725 (26AWG*1PR+D+AM)x2C+24AWG*2C+AM+B OD:5.4mm PVC JACKET COLOR:BLACK
2.	CONNECTOR:USB 2.0 A/M, 4P, WHITE INSULATOR SOLDER TYPE, NICKEL PLATED SHELL
3.	CONNECTOR:USB 2.0 B/M, 4P, WHITE INSULATOR SOLDER TYPE, NICKEL PLATED SHELL
4.	PVC MOLDED HOUSING, BLACK COLOR

Jargy part no.	Client part no.	Approved	SCALE	UNIT
CBL-HFD203-Xm			1 : 1	mm
Drawing Name		Drawn	Date	REV.
USB 2.0 A to B Cable M/M		<i>Kevin Asu</i>	2015/09/03	1.0



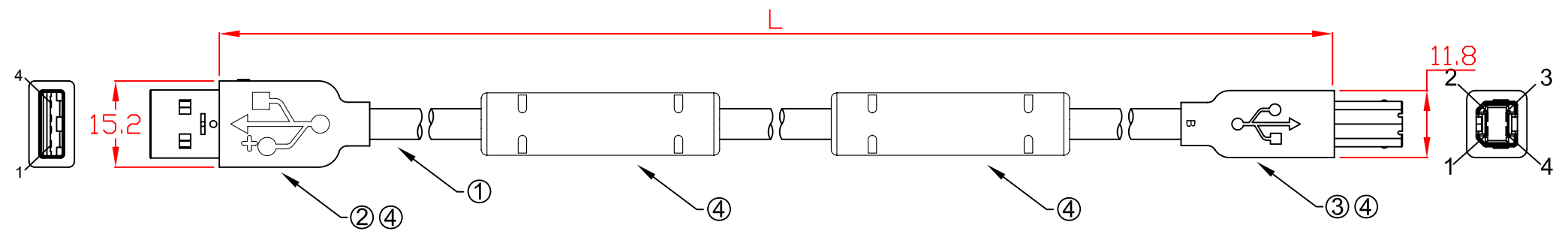
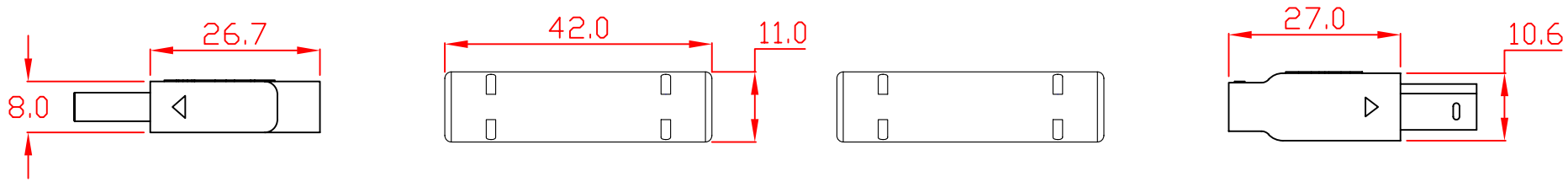

L:
 CBL-HFD203-25m 25000mm±50mm
 CBL-HFD203-30m 30000mm±50mm

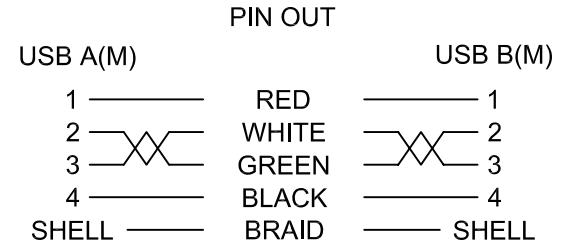

No	MATERIALS LIST:
1.	CABLE:UL2725 (26AWG*1PR+D+AM)x2C+24AWG*2C+AM+B OD:5.4mm PVC JACKET COLOR:BLACK
2.	CONNECTOR:USB 2.0 A/M, 4P, WHITE INSULATOR SOLDER TYPE, NICKEL PLATED SHELL
3.	CONNECTOR:USB 2.0 B/M, 4P, WHITE INSULATOR SOLDER TYPE, NICKEL PLATED SHELL
4.	PVC MOLDED HOUSING, BLACK COLOR

Jargy part no.	Client part no.	Approved	SCALE	UNIT
CBL-HFD203-Xm			1 : 1	mm
Drawing Name		Drawn	Date	REV.
USB 2.0 A to B Cable M/M		<i>Kevin Asu</i>	2015/09/03	1.0

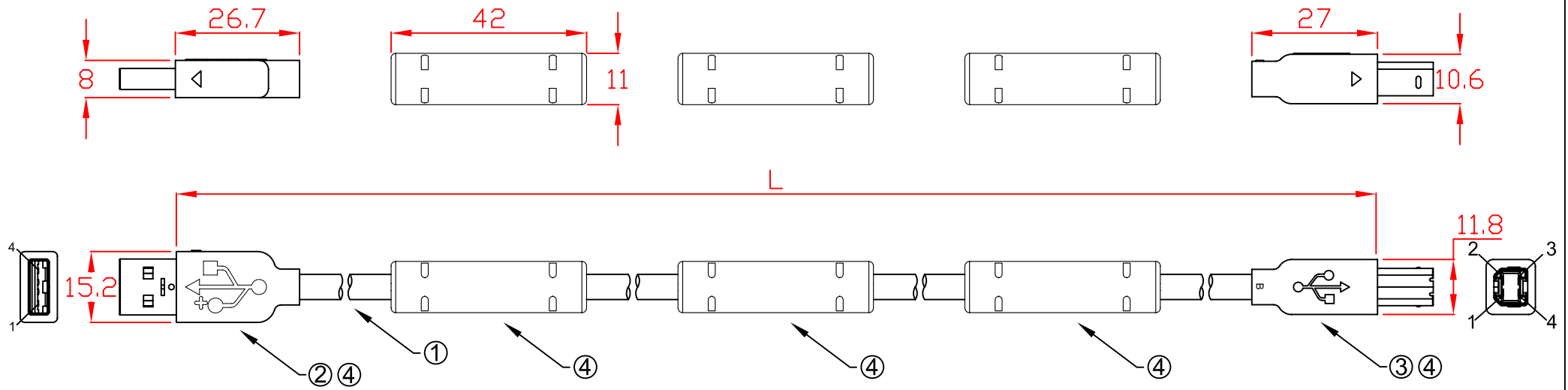

L:
 CBL-HFD203-35m 35000mm±50mm
 CBL-HFD203-40m 40000mm±50mm

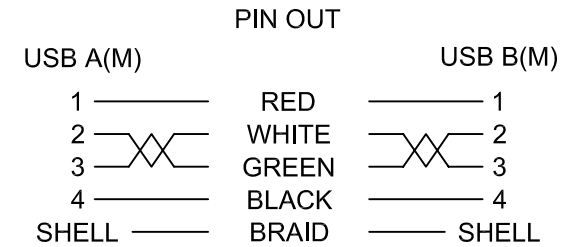

No	MATERIALS LIST:
1.	CABLE:UL2725 (26AWG*1PR+D+AM)x2C+24AWG*2C+AM+B OD:5.4mm PVC JACKET COLOR:BLACK
2.	CONNECTOR:USB 2.0 A/M, 4P, WHITE INSULATOR SOLDER TYPE, NICKEL PLATED SHELL
3.	CONNECTOR:USB 2.0 B/M, 4P, WHITE INSULATOR SOLDER TYPE, NICKEL PLATED SHELL
4.	PVC MOLDED HOUSING, BLACK COLOR

Jargy part no.	Client part no.	Approved	SCALE	UNIT
CBL-HFD203-Xm			1 : 1	mm
Drawing Name		Drawn	Date	REV.
USB 2.0 A to B Cable M/M		<i>Kevin Asu</i>	2015/09/03	1.0

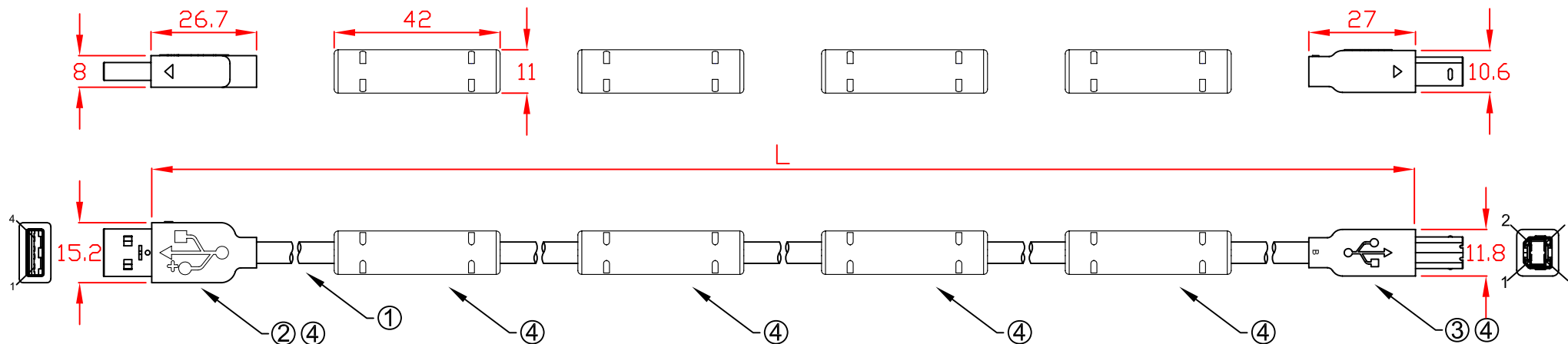

L:
 CBL-HFD203-45m 45000mm±50mm
 CBL-HFD203-50m 50000mm±50mm

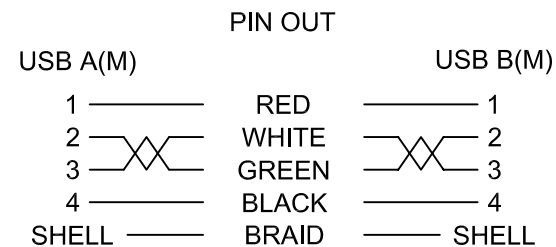

No	MATERIALS LIST:
1.	CABLE:UL2725 (26AWG*1PR+D+AM)x2C+24AWG*2C+AM+B OD:5.4mm PVC JACKET COLOR:BLACK
2.	CONNECTOR:USB 2.0 A/M, 4P, WHITE INSULATOR SOLDER TYPE, NICKEL PLATED SHELL
3.	CONNECTOR:USB 2.0 B/M, 4P, WHITE INSULATOR SOLDER TYPE, NICKEL PLATED SHELL
4.	PVC MOLDED HOUSING, BLACK COLOR

Jargy part no.	Client part no.	Approved	SCALE	UNIT
CBL-HFD203-Xm			1 : 1	mm
Drawing Name		Drawn	Date	REV.
USB 2.0 A to B Cable M/M		<i>Kevin Asu</i>	2015/09/03	1.0